

USER'S GUIDE

EE150 - Humidity and Temperature Transmitter for HVAC applications

SCOPE OF SUPPLY

- EE150 transmitter, type number according to order (for ordering guide see data sheet at www.epluse.com/EE150)
- Cable gland M16 x 1.5
- Mounting flange, PC, Ø 6.0mm
- Test report according to DIN EN 10204 – 2.2

CAUTION

- For accurate measurement it is essential that the temperature of the probe and mainly of the sensing head is same as the temperature of the air to measure.
- Avoid mounting the EE150 transmitter in a way which creates temperature gradients along the probe. If possible, EE150 shall be installed with the entire probe inside the duct. For installation with mounting flange, in case of different temperature inside and outside the duct, the probe part outside the duct shall be thermally isolated.
- The device and mainly the sensing head shall not be exposed to extreme mechanical stress.
- Do not attempt to remove the filter cap, which is fixed. Avoid touching the sensing head at all times.
- The stainless steel probe is ESD sensitive and shall be handled as such. Do not connect it to the ground potential.

CONNECTION DIAGRAM

EE150-HT6xxx

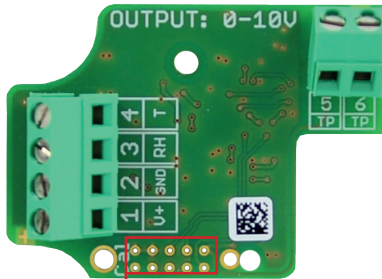

setup and adjustment interface (with EE-PCA)

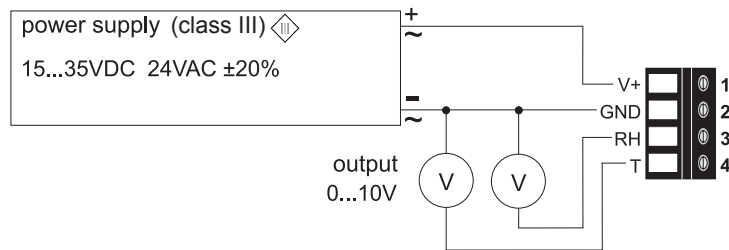

T-passive connection for HT3xxx/HT6xxx

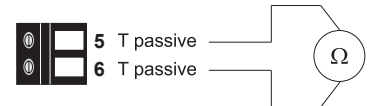

EE150-HT3xxx

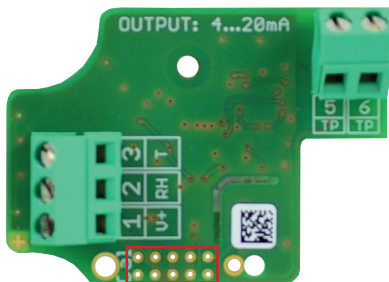

setup and adjustment interface (with EE-PCA)

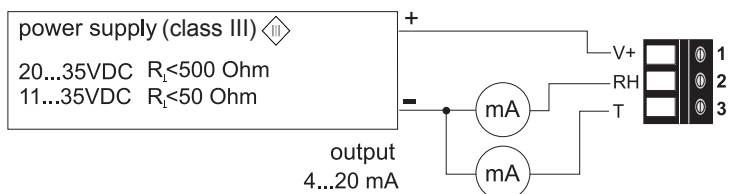

DIMENSIONS / MOUNTING

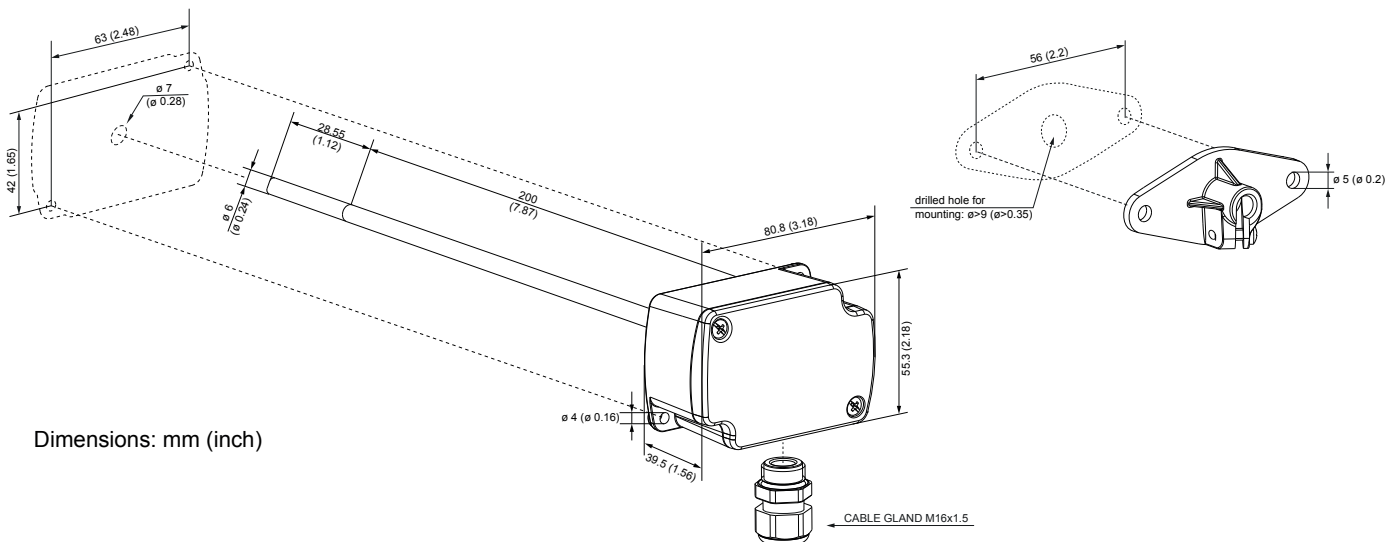

Dimensions: mm (inch)

TECHNICAL DATA

(Modification rights reserved)

Measured values

Relative Humidity

Working range	10...90% RH
Accuracy at 20°C	±3% RH (30...70%RH), otherwise ±5% RH
Temperature dependency	typ. ±0.05% RH/°C

Temperature

Working range	-5...55°C (23...131°F)
T-Accuracy at 20°C	±0.3°C

Outputs

Analog output	0-10 V	$R_t \geq 10k \text{ Ohm}$
(0...100% RH; T: see ordering guide)	4-20 mA (2-wire)	$R_t \leq 500 \text{ Ohm}$

Passive T-sensor

2-wire	see ordering guide
Wires resistance (terminal - sensor)	typ. 0.5 Ohm

General

Power supply (Class III) 	15 - 35V DC or 24V AC ±20%
for 0 - 10 V	10V + $R_t \times 20 \text{ mA} < U_v < 35V \text{ DC}$
for 4 - 20 mA	
Current consumption	with DC power supply typ. 5mA with AC power supply typ. 13mA _{eff}
Connection	Screw terminals, max. 1.5 mm ²
Housing material	Polycarbonate, UL94V-0 approved
Protection class	IP65/NEMA 4
Cable gland	M16 x 1.5
Sensor protection	PTFE filter, non-removable
Electromagnetic compatibility	EN61326-1 EN61326-2-3 Industrial environment FCC Part 15 Class B ICES-003 Issue 5 Class B
Working conditions	-5...55°C (23...131°F) 0...95% RH (non-condensing)
Storage conditions	-25...60°C (-13...140°F) 20...80% RH



SETUP AND ADJUSTMENT

The EE150 is ready to use and does not require any configuration by the user. The factory setup of EE150 corresponds to the type number ordered. For ordering guide please see data sheet at www.epluse.com/EE150.

If needed, the user can change the factory setup by using the optional E+E Product Configuration Adapter (EE-PCA) and the E+E Product Configuration Software (EE-PCS). With these one can set the output scaling, and perform one or two point adjustment for humidity and temperature.

For product data sheet EE-PCA please see www.epluse.com.

The E+E Product Configuration Software (EE-PCS) is free and can be downloaded from www.epluse.com/configurator.

USA

FCC notice:

This equipment has been tested and found to comply with the limits for a Class B digital device, pursuant to part 15 of the FCC Rules. These limits are designed to provide reasonable protection against harmful interference in a residential installation. This equipment generates, uses and can radiate radio frequency energy and, if not installed and used in accordance with the installation manual, may cause harmful interference to radio communications. However, there is no guarantee that interference will not occur in a particular installation. If this equipment does cause harmful interference to radio or television reception, which can be determined by turning the equipment off and on, the user is encouraged to try to correct the interference by one or more of the following measures:

- Reorient or relocate the receiving antenna.
- Increase the separation between the equipment and receiver.
- Connect the equipment into an outlet on a circuit different from that to which the receiver is connected.
- Consult the dealer or an experienced radio/TV technician for help.

CANADIAN

ICES-003 Issue 5:

CAN ICES-3 B / NMB-3 B

INFORMATION

+43 7235 605 0 / info@epluse.com

Langwiesen 7 • A-4209 Engerwitzdorf
Tel: +43 7235 605-0 • Fax: +43 7235 605-8
info@epluse.com • www.epluse.com

LG Linz Fn 165761 t • UID-Nr. ATU44043101
Place of Jurisdiction: A-4020 Linz • DVR0962759

